

## FLEXO WIDE WEB PORTFOLIO



FULLY AUTOMATIC FAMM 3.0



AUTOMATIC SAMM 2.0



SEMI-AUTOMATIC MOM DD+ Pro



MOTORIZED MOM DD S



## SUPPORTING EQUIPMENT



TIR



SLEEVE STORAGE SYSTEM



PRINTING SLEEVES



DEMOUNTER

## COMPLETE FLEXO SOLUTIONS FOR EVERY FLEXOGRAPHIC PRINTER

AV Flexologic is the global leader in automatic mounting and pre-press solutions. With **1,000+ automatic mounters** installed in all-over the world the last 15 years, AV Flexologic offers the most accurate, fast and reliable mounting machines for the flexo industry.

AV Flexologic's solutions vary from motorized to robotic ones, depending on your needs.



### Levels of automation

	Level 1	Level 2	Level 3	Level 4
<b>Mounting Machine</b>	<b>Motorized MOM DD S</b>	<b>Semi-Automatic MOM DD+ Pro</b>	<b>Automatic SAMM 2.0</b>	<b>Fully Automatic FAMM 3.0</b>
Operator interaction	The operator positions the plate manually	The operator positions the plate manually.	The operator only pre-positions the plate on the mounting table	The operator only places the plates on the conveyor belt
Mounting Automation	Manual mounting with automatic cameras and a mounting table	Semi-auto mounting with automatic cameras, mounting table, pressure roller	Automatic mounting of each plate without operator interaction	Fully automatic mounting of multiple plates
Mounting Capacity	1 sleeve and 1 plate mounted at a time	1 sleeve and 1 plate mounted at a time	1 sleeve and 1 plate mounted at a time	1 sleeve and multiple plates mounted one after another
Positioning Accuracy & Time/plate	•Depends on the operator	•Depends on the operator. Optional Image Recognition assistance	•5µm accuracy •60 seconds/plate	•2µm accuracy •29 seconds/plate

## FAMM 3.0

FULLY AUTOMATIC FLEXTO PLATE  
MOUNTING MACHINE

## Widths

Width [mm]	≤ 1300, 1700, 2200
Width [inch]	52", 67", 87"
Max repeat [mm/inch]	1350 / 53"

## Description

The FAMM 3.0 is the next generation fully automatic mouter that continues to change the dynamics in mounting departments, a change that first started in 2005 with the ground-breaking technology of the original FAMM.

This machine is the most advanced automatic mounting solution that provides incomparable **speed, repeatability and accuracy**. It has been developed for our customers who demand the highest standards and aim in an optimized and highly efficient pre-press workflow, that allows an enormous **increase** in their **capacity** and a **higher overall print quality with fast changeovers**.

The patented FAMM 3.0 is the ideal solution for **short and frequent job runs**. This machine has been completely redesigned during the past 2 years and it is equipped with an updated software which allows more synchronous movements. This intelligent system controls the interactive cameras that read the digital positions of the mounting marks using the patented Image Recognition and a robotic manipulator that picks-up the plates and positions them with an **extreme accuracy down to 2µm**.



## Unique Features

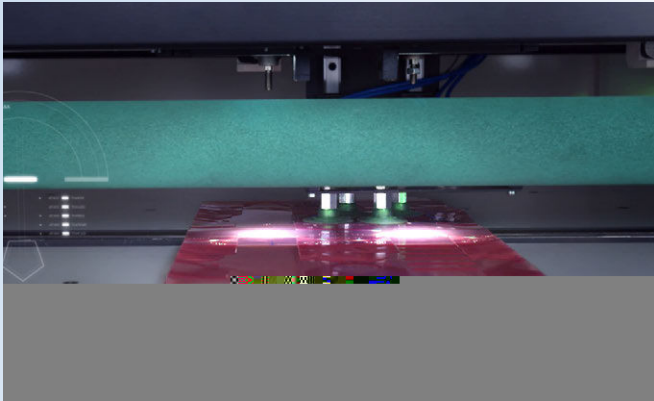

### Robotic pick-up unit

The pick-up unit is completely re-designed and it is used to transfer the plate from the conveyor belt to the mounting position. Using robotics the flexo plate is automatically positioned with an accuracy of **2 microns**



### Linear motors

The Ultra HD cameras move automatically into position using the linear motors which provide **phenomenal speed and accuracy**. Therefore, the mounting and quality checking time has been reduced enormously.

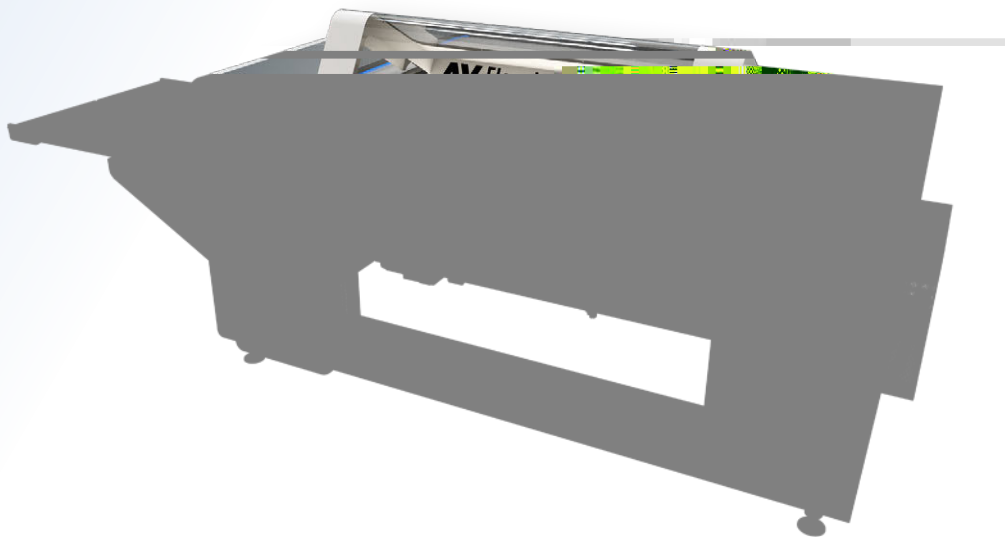

### Conveyor back-light

The new split conveyor belt is able to identify the plate from the bottom and to read **QR codes**. The conveyor back light and laser line allows plates to be aligned easier.

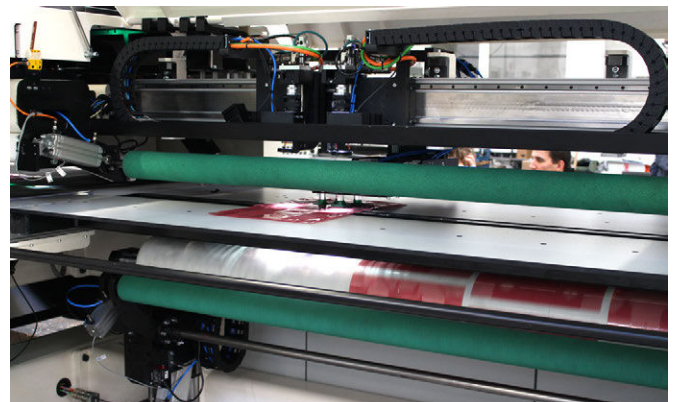

### Second pressure roller

The top pressure roller mounts half of the plate, then the mandrel lowers down so that the second pressure roller can mount the rest of the plate. During this time, the pick-up unit has already placed the next plate for mounting, optimizing the mounting time with **synchronous movements**.



## FAMM 3.0 Unique Features

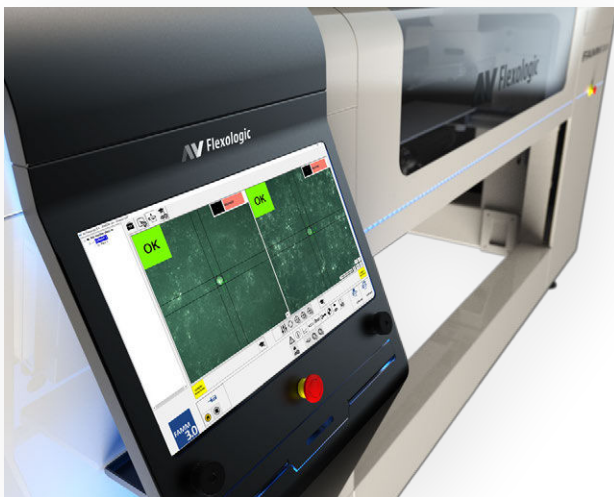

### Accuracy of 2 microns

The FAMM 3.0 uses the patented **Image Recognition** software that measures the exact position of the mounting marks. The robotic manipulator uses these measurements to position the flexo plate with an unmatched accuracy of 2 microns.

### Updated software

The updated software allows more synchronous movements and it features a more intuitive user interface.

### Automatic mandrel rotation

When the printing plate is positioned accurately and within the chosen tolerance, the cylinder moves up and the pressure roller fixates the plate. The cylinder rotates automatically and the plate is mounted within seconds. When the plate is mounted, the cylinder moves vertically down allowing a fully automatic operation.



### Status LEDs

Depending on the status of the mounting process, the LED lights indicate whether an action needs to be taken.

Default

Operating

Advisory

Error



# Mounting Marks Specifications

The Automatic SAMM and the Fully Automatic FAMM use the patented Image Recognition to identify the mounting marks and based on them, position the flexo plate accurately.

Type of target	Compatible mode	Plate type	Target top size**		Free space around target		Top of target
			Minimal	Advised	Shape	Size	
Positive dot	Blob	Processed	0.4mm	0.5-0.6mm	Circle	1mm	Flat no image
		Thermal	0.45mm	0.5-0.6mm			
	Correlation	Processed	0.4mm	0.5-0.6mm	Square		
		Thermal	0.45mm	0.5-0.6mm			
Negative dot	Blob	Processed	0.6mm	0.6-1mm	Circle		
	Correlation	Processed	0.6mm	0.6-1mm	Square		
Positive non-dot shapes	Correlation	Processed	2mm	2-4mm	Square		
		Thermal	2mm	2-4mm	Square		
W&H register mark	Easyreg®	-	-	-	-	-	
Damaged targets*	Semi Auto	See specs of the original target					

\* It is possible to mount damaged targets using the Semi-Automatic mode. The operator will have to locate the target once, after that the FAMM/SAMM will mount these plates automatically. Also the quality check after mounting is available.

\*\* Microdots with a smaller diameter than 0.4mm can become unstable and can deteriorate following printing

\*\*\*When possible, it is recommended to avoid screening such as pixel+ on the mounting mark for optimal recognition. When using a laser to apply the screening, the screening can be avoided using object-based selective screening in the prepress software.

## Mounting marks types

The FAMM/SAMM detects all common mounting marks and microdots within the above specifications.

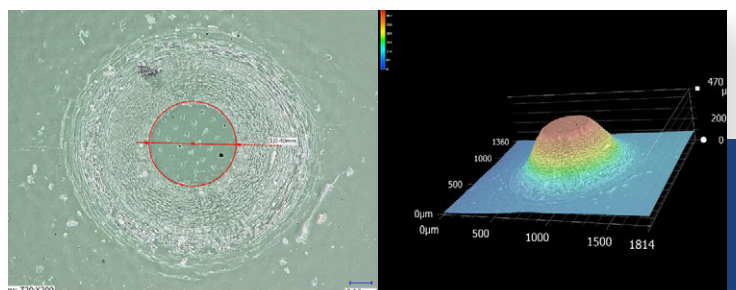
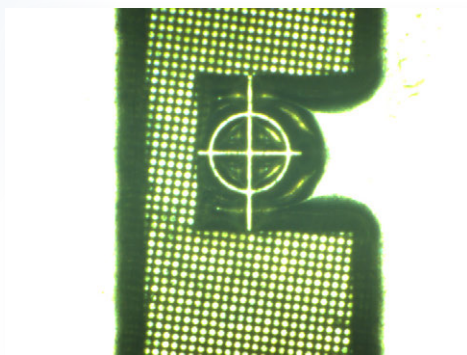
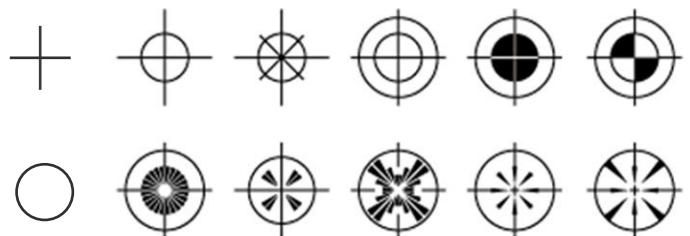



## Ground-breaking Innovation



- ✓ Fully automatic tape application
- ✓ Robotic loading of flexo plates
- ✓ Robotic loading/unloading of sleeves

The operator places the **Tech Cart** inside the ROBOCELL and selects a job from the HMI console. The **Robot** will then take the first sleeve and **apply tape automatically** (RoboTAPE). Following, it will **load** the taped sleeve on the **FAMM 3.0**.

The **plate loader** (ROBOPLATE) contains the required plates for the specific job. The second **robotic unit** will pick-up the plates and place them on the conveyor belt. Then, the **robotic manipulator** of the FAMM 3.0 will take the first plate and position it with an accuracy of 2 microns. When the mounting process is completed as explained before, the Robot will unload the mounted sleeve and place it back on the Tech Cart. The same process is repeated until all the sleeves of the selected job are mounted.

As a reference, the sleeves of a 10-color job can be taped and mounted fully automatically in **less than 25 minutes** beginning to end.

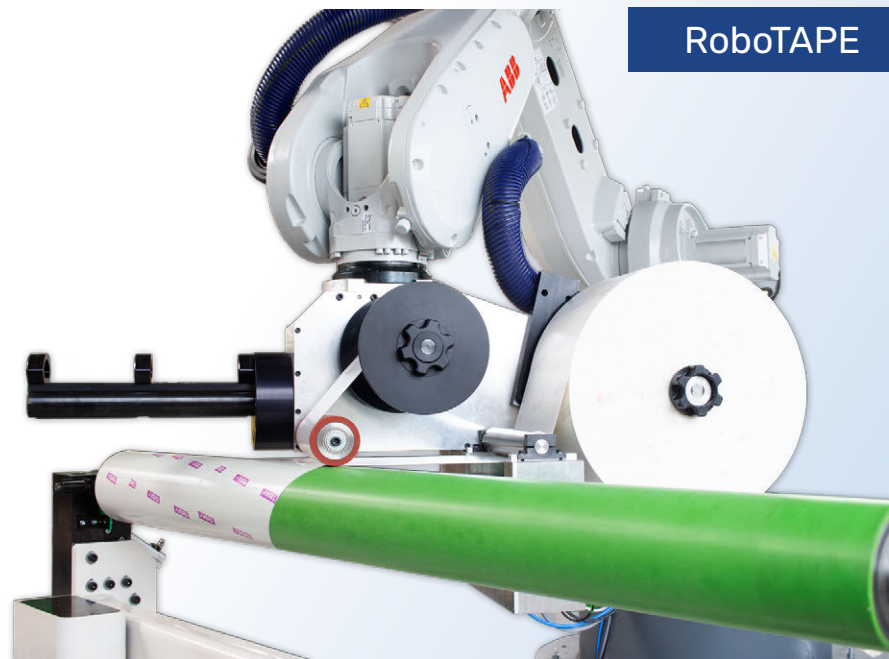

RoboTAPE



RoboCELL

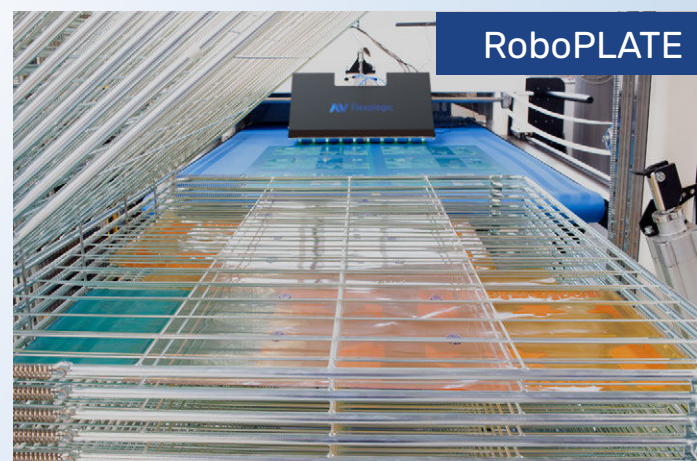

RoboPLATE



## SAMM 2.0

# AUTOMATIC FLEXO PLATE MOUNTING MACHINE

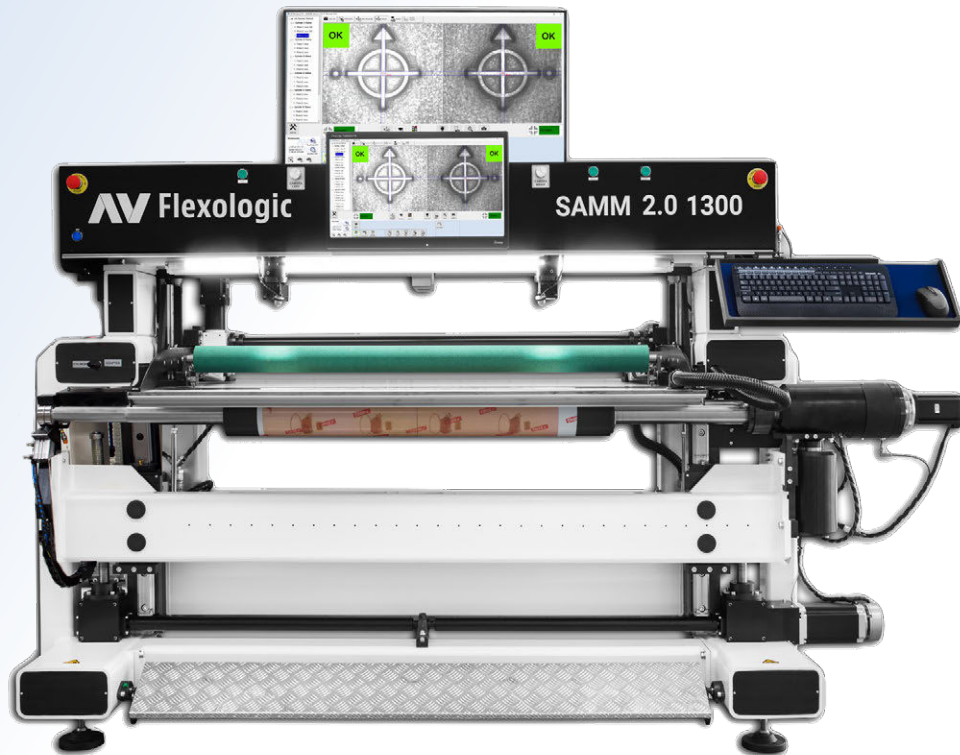

### Widths

Width [mm]	≤ 1300, 1700, 2200
Width [inch]	52", 67", 87"
Max repeat [mm/inch]	1350 / 53"

### Description

The patented **SAMM 2.0** is AV Flexologic's solution to common industry trends. With **600+** automatic mounters installed in all over the world the last 15 years, the Automatic SAMM is the world's **most reliable** mounter that guarantees unmatched **accuracy, repeatability and speed**.

### Workflow

The operator only needs to preposition roughly the flexo plate with the help of the laser pointers. Then the machine takes over and positions the flexo plate using **robotics**. Additionally, with the help of motorized cameras and the patented **Image Recognition** software, the flexo plate is placed with an accuracy of **5 microns**. Following, the motorized front table automatically moves and the flexo plate is mounted onto the sleeve without **any operator interaction**. During the mounting process, the operator can focus on other preparatory tasks. The SAMM 2.0 features a staggering **60-second** mounting speed, attending to higher quality demands and reducing press downtime.

## Unique Features

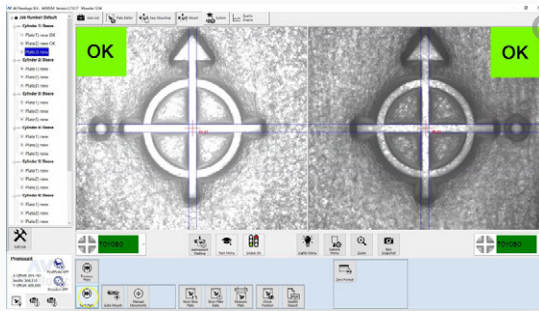

### Image Recognition (patented)

The image recognition system measures the exact positions of the mounting marks and thus how **accurately** the printing plate is fixed on the sleeve. The tolerance of the report settings determines whether a plate is judged as mounted 'OK' or 'NOT OK'.

If the plate is not mounted within the set tolerance, the machine **will not proceed** to the next plate. Thus, **it is impossible** to send to the press plates with **mounting mistakes**.

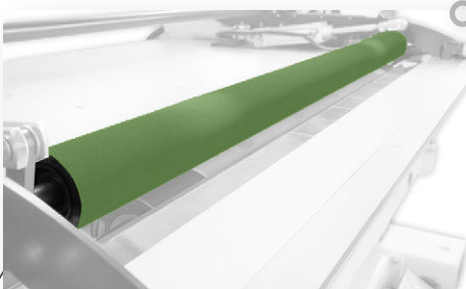

### Pressure Roller

The pressure roller ensures even mounting, without **any air inclusions** and bubbles. The feature saves time and avoids un-ergonomic working procedures.

The pressure roller can also be used for an efficient and fast **tape application**. The operator attaches a pre-cut piece of tape onto the sleeve or uses the tape holder. Then by enabling the **pressure roller and rotating the sleeve**, the tape is applied evenly without bubbles. The tape overlap can be cut with the optional **cutting knife** that has an adjustable depth and doesn't cut through the sleeve.

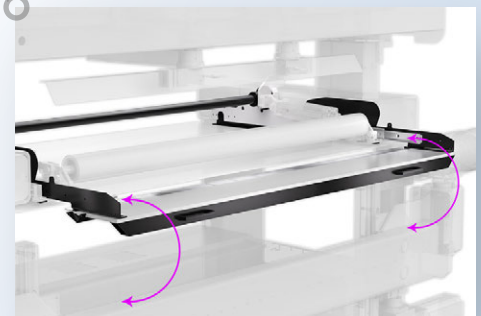

### Motorized vacuum table

An added advantage of the SAMA 2.0 is the motorized front table, which enables the machine to **fully automatically** mount individual printing plates without operator interaction, keeping the performance of the mounting job with an accuracy of **5 microns**. During the time the machine is mounting each plate, the operator can prepare the next plate or perform another preparatory or finishing operation.

## MOM DD+ Pro

# SEMI-AUTOMATIC FLEXO PLATE MOUNTING MACHINE



### Widths

Width [mm]	≤ 1300, 1700, 2200
Width [inch]	52", 67", 87"
Max repeat [mm/inch]	1350 / 53"

## Description

The **MOM DD+ Pro** is our semi-automatic mounting machine, which has advanced features for an easy and accurate plate mounting. Key options are available such as image recognition, vacuum table, a tape holder, automatic W&H Easyreg detection, and a digital TIR measuring system, which can also map the full surface of the sleeve.

## Workflow

The operator selects the plate from the job menu and the motorized cameras move automatically to the mounting position. The operator positions the plate manually with the help of laser pointers. After positioning, the operator selects to **move the cylinder up vertically**, lowers the pressure roller and rotates the cylinder using the foot pedal. After mounting, the operator can select to check the position of the mounting marks. The machine automatically takes a snapshot and generates a **PDF report on the fly**.

The machine provides benefits to an operator in multiple ways. Through motorization, the flexo plate mounting process requires a lot less operator interference. The **added advantage** of the MOM DD+ Pro is the **vertically moving cylinder**, which means that there is **no need to focus the cameras** when mounting plates onto sleeves with different repeats.



## Unique Features



### Automatic moving HD cameras

The MOM DD+ Pro is equipped with HD Ethernet cameras that move automatically onto the mounting position. The operator only needs to create the job and select the plate that wants to mount.

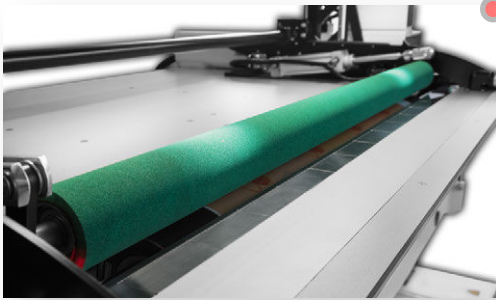

### Pressure Roller

The pressure roller ensures even mounting, without **any air inclusions** and bubbles. The feature saves time and avoids un-ergonomic working procedures.

The pressure roller can also be used for an efficient and fast **tape application**. The operator attaches a piece of tape onto the sleeve or uses the tape holder. Then by enabling the **pressure roller and rotating the sleeve**, the tape is applied evenly without bubbles. The tape overlap can be cut with the optional **cutting knife**, or a cutter.

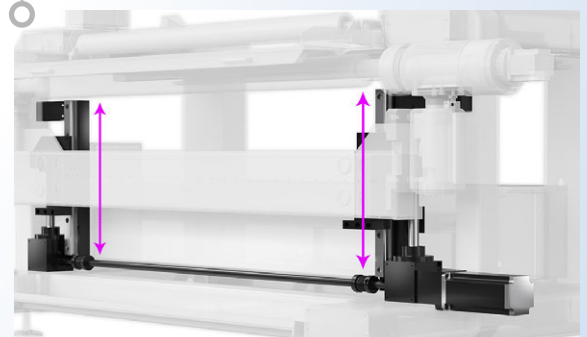
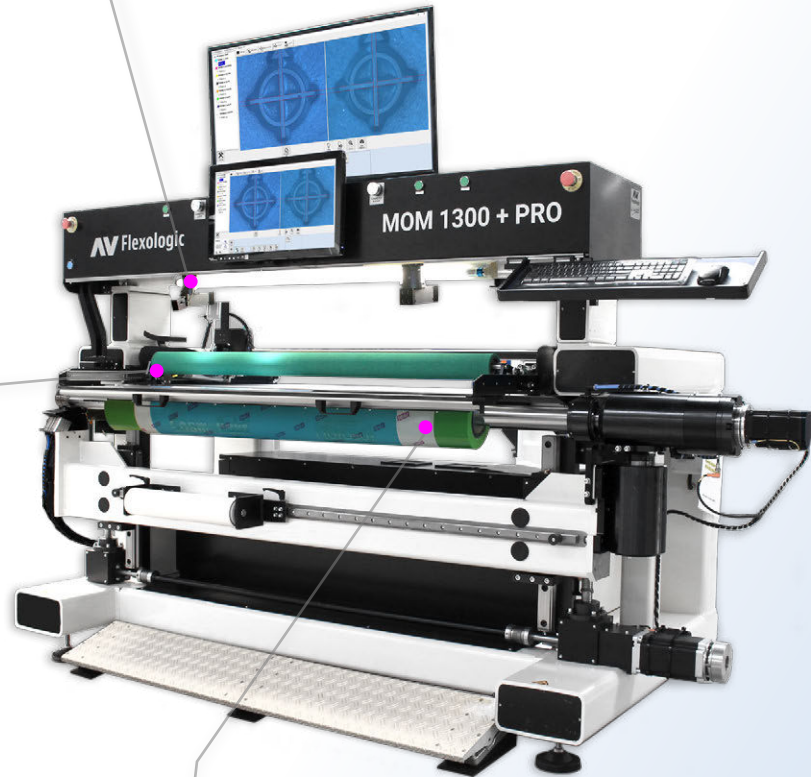

### Vertically moving cylinder

There are several advantages of having the cylinder move vertically towards a fixed-height mounting table. For one this ensures a **fixed distance from the lens to the plate**, eliminating the need to focus the camera lenses. Avoiding focusing the lenses also means avoiding the parallax effect common to most plate mounting machines on the market since when changing the focus distance the 'focal point' also varies which distorts the calibration of the cameras. To ensure a fixed distance from the camera to the printing plate, instead of focusing the cameras to compensate diameter variations of the sleeve, the height of the cylinder is adjusted depending on the outer diameter of the sleeve.

## Unique options MOM DD+ Pro

### Image Recognition System

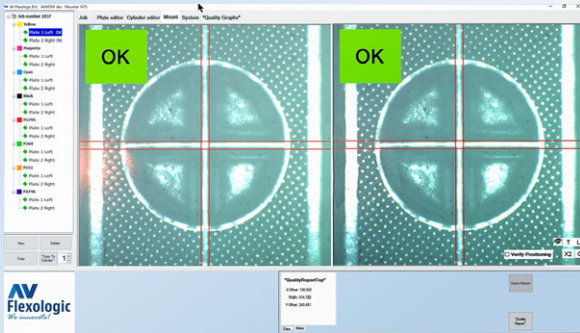

Unique to the MOM DD+ Pro is the optional Image Recognition system, which is also included in the SAMM and FAMM automatic mounting machines. AV Flexologic has developed image recognition based **Quality Control** and intelligent **positioning assistant** on the MOM DD+ Pro. With the positioning assistant the workflow remains the same, however the image recognition system constantly measures the position of the mounting marks. When the operator has positioned the plate by hand to within a user-set tolerance, the MOM gives the 'OK' and the cylinder automatically moves up to fix the plate to the adhesive on the sleeve.

### Tape holder on precision rail

A tape holder can optionally be added on precision linear guides. The linear guides make sure the tape roll is completely parallel to the sleeve when applying tape and assist the operator to easily move the tape along the side of the sleeve.

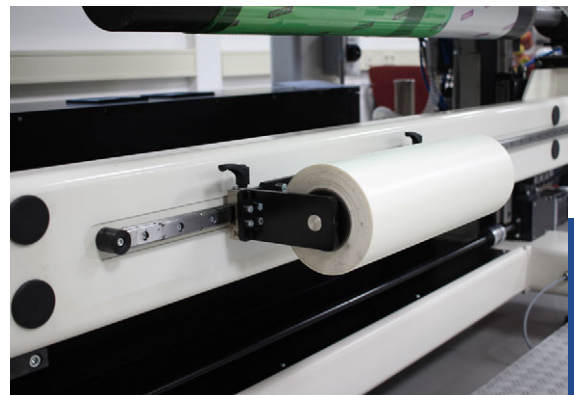

### Cutting knife for tape and plates

A special cutting knife with precise depth adjustment can be added on the camera beam. The cutting knife can be easily slid through the beam and cut the tape effortlessly and without damaging the printing sleeve.

### Automatic Easyreg detection

Another feature which uses image recognition is the automatic zero-setting feature for detecting a visual mark on the edge of the sleeve. The machine automatically scans the edge of the sleeve to look for the visual mark. Once this mark is recognized, the sleeve is centered and set to zero on this visual mark, to which the plates are mounted. The printing press picks up this mark (such as the W&H Easyreg mark) and the registration of the decks is done automatically. It is also possible to detect the precise location of a magnet in the edge of the sleeve for printing presses such as BOBST, SOMA and Allstein.



## MOM DD+ Pro vs. MOM DD S

Both mounters have a vertical moving cylinder and there is no need to focus the cameras. The main difference between these two mounters is the **level of automation** and their optional features. The **MOM DD S** has a basic PC to enter the repeat size of the sleeve and the positions of the mounting marks.

The **MOM DD+ Pro** comes standard with a mounting table and a pressure roller. It is equipped with a PC and a **Windows 10** based AV MOM software, which allows easy job creation and storage. Additionally, the MOM DD+ Pro has many optional features that ensure accurate and consistent mounting each time.

### MOM DD S



### MOM DD+ Pro



Features & Options	MOM DD S	MOM DD+ Pro
Max printing width	1300/1700 mm	1300/1700/2200mm
Automatic Cameras	✓	✓
Air mandrel	✓	✓
Motorized rotation of cylinder	✓	✓
Fixed distance from lens to plate	✓	✓
Vertical Movement of Cylinder	✓	✓
Mounting table	✓	✓
Laser pointers	✓	✓
Touchscreen	✓	✓
Camera encoders	✓	✓
Pressure roller	○	✓
Tape holder on precision rail	○	○
Cutting knife for tape and plates	○	○
Windows 10 mounting software		✓
Overlay		✓
Digital Zoom capability		✓
Quality Report		✓
Digital Calibration System		✓
Image Recognition Software		○
Quality check w/ image recognition		○
Barcode Scanner		○
Automatic Easyreg detection		○
Shaft Coupling for cylinders		○
TIR Sleeve measurement		○
Sleeve Tracking System*		○

= Included ○ = Optional  
\*only in combination with TIR



## MOTORIZED FLEXPLO PLATE MOUNTING MACHINE



### Widths

Width [mm]	≤ 1300, 1700
Width [inch]	52", 67"
Max repeat [mm/inch]	1350 / 53"

### Description

The MOM DD S is the industry-wide standard in mounting machines for mounting flexographic printing plates onto sleeves with manual positioning of printing plates. The MOM DD S is a cost efficient alternative to the MOM DD+ Pro.

### Workflow

The operator creates a job by entering the X and Y coordinates, and the repeat size in the system. By selecting to start mounting, the cameras move automatically into the mounting position of the first plate. The vertically moving cylinder comes up to the mounting position and there is no need to focus the cameras since the mounting table is at a fixed height.

Then, the operator positions the plate manually with the help of a large screen. When the plate is positioned, the operator rotates the motorized cylinder using the foot pedal and the plate is mounted. An optional pressure roller can be added to the machine for better quality mounting without air inclusions. When the mounting process is completed, the air chrome mandrel can be unlocked to remove the sleeve.

## Unique Features



### Automatic moving HD cameras

The MOM DD S is equipped with HD cameras that move automatically onto the mounting position. The operator only needs to enter the X and Y position of the marks in the system.

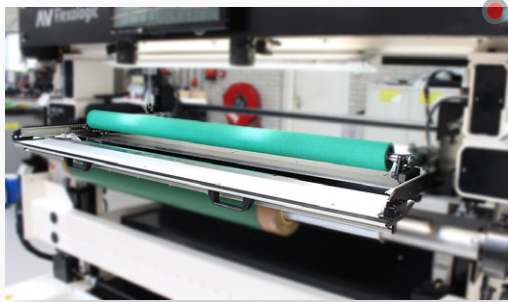

### Mounting table

The mounting table helps in positioning the plate easier as it provides more stability. It also allows a fixed distance between the plate and the camera lens. Therefore, there is no need to focus the cameras.

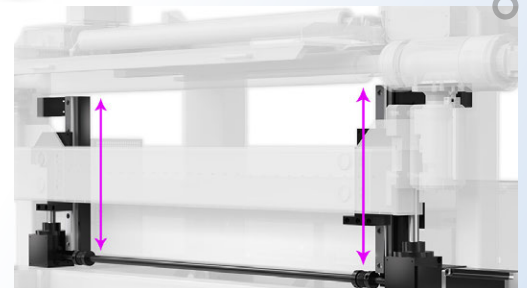
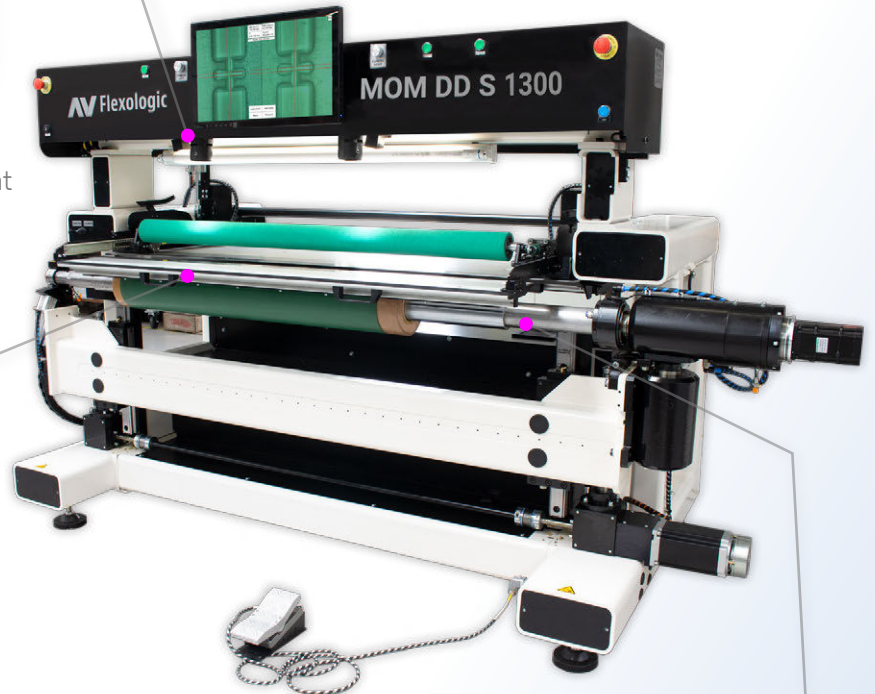

### Vertically moving cylinder

The cylinder moves vertically up depending on the repeat size of the sleeve. In combination with the mounting table, these features eliminate the need to focus the cameras. Therefore, consistent high-quality image of the mounting marks is ensured.

### Pressure roller (optional)

Combining a fixed-height mounting table with a full-width and open-cell **pressure roller** is the ideal combination for a motorized mounting machine.

When the plate is in position, the pressure roller is lowered to fix the plate firmly onto the adhesive without air inclusions. Compared to traditional mounting machines, the pressure roller saves enormous operator time and reduces press downtime due to the elimination of air enclosures.

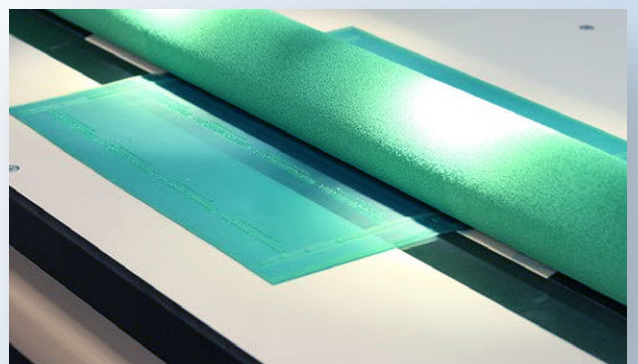

## Features Overview



### Robotic positioning

Driven by the AV Flexologic software, the robotic table positions the mounting plate with high accuracy, each and every time. After positioning the vertically moving cylinder automatically comes up.

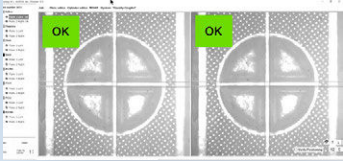

### Quality check with image recognition

The image recognition system measures the exact positions of the mounting marks and thus how accurately the printing plate is fixed on the sleeve. The tolerance of the report settings determines whether a plate is judged as mounted 'OK' or 'NOT OK'.

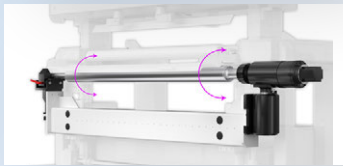

### Motorized rotation cylinder

The chromed cylinder is driven by a high quality electric motor which is joined to a high-precision, zero backlash gear reducer called a 'harmonic drive'. This ensures maximum possible precision in the rotational (Y) direction of the mounting process. Starting or recalling a job and moving to the right mounting position for each plate is done within seconds.



### HD Ethernet cameras

Using the latest technology in high-speed Ethernet cameras on all of the mounting equipment, AV Flexologic ensures crisp and sharp ultra-high-resolution images, enabling an efficient and accurate mounting process.

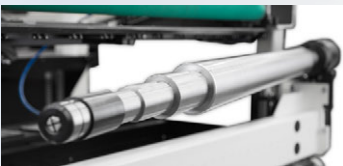

### Custom made Air Cylinder

All sleeve-dedicated AV Flexologic mounting equipment is equipped with a high-precision chromed mounting mandrel. The cylinders are produced in Germany by a specialist company under the strictest tolerances. The cylinder is custom-made to fit press requirements.

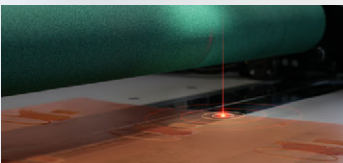

### Laser pointers

Laser pointers are mounted next to the cameras to indicate where the field of view of the cameras is. The mounting marks can be easily positioned in a fraction of time, instead of having to search for the mounting marks in the camera image each time.

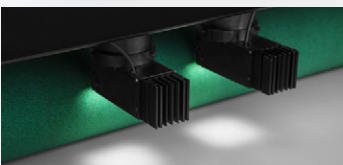

### DOAL lights

The image recognition system includes special DOAL lights with a half-transparent mirror which provide the best recognition conditions for automatic mounting. The light comes from the side and is reflected down in the same direction the camera is looking. When the light hits the plate surface it reflects straight back up into the lens.

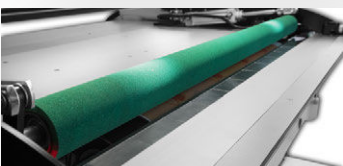

### Pressure roller

The pressure roller has become a standard feature in AV Flexologic flexo plate mounting machines over recent years. The roller is used to apply the plates evenly over the carrier such as a sleeve, cylinder or Mylar. The use of the pressure roller eliminates the typical 'hand-rolling'. The feature saves time and avoids un-ergonomic working procedures.

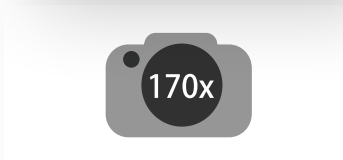

### Digital zoom capability

Combining HD cameras with HD flatscreen monitors enables mounting equipment to zoom digitally up to 170x.





## Windows 10 mounting software

Striving for the latest up to date technology, the SAMM 2.0 is equipped with Windows 10, which is fully compatible with our software.

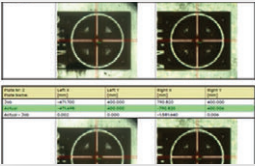

## Quality report

After each plate is mounted, the MOM, SAMM and FAMM mounting machines have the ability to automatically check the tolerance of mounted plates using image recognition. A pdf quality report is generated on-the-fly with ability to check top and bottom.

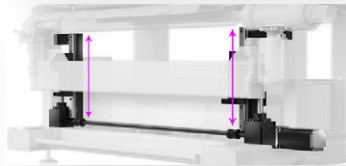

## Vertical movement of cylinder

The cylinder moves vertically on high-precision linear guides. Advantages are that by moving the cylinder towards the plate, the plate is not disturbed in the final stage of the mounting process, meaning the 'fixation' accuracy of the plate to the sleeve is very high. Also, fixed distance from lens to plate means that there is no need to focus the lenses, ensuring the highest accuracy and user-friendliness.



## Fixed distances from the lens to plate

The table is in a fixed height, so the cylinder moves up vertically when the plate is in position to fix the plate to the sleeve's adhesive layer (tape or twinlock). One of the advantages is that a fixed working height ensures best operator ergonomics.

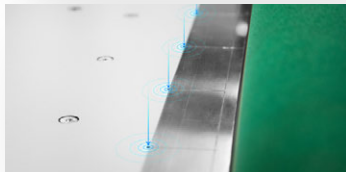

## Vacuum table

To ensure highly accurate positioning, the vacuum system fixates the plate to the robotic table before positioning.



## Digital calibration system

Digital Y-calibration of the camera beam: the camera images are used in a calibration procedure to create a lookup table and digitally 'straighten' any deviations in the camera beam, down to 10 µm over the entire width of the camera beam / sleeve. For every x-position of the camera the y-deviation is recalled, the image is automatically digitally adjusted, ensuring 100x more accurate mounting. Additionally, the measured Y-deviation is stored in a lookup table.



## 40" HD Monitor

To be able to optimally view the mounting marks during the mounting process, the MOM and SAMM machines have a large-format HD Mounting monitor mounted on top of the machine. In combination with the HD Ethernet cameras. The magnified images are viewed with a high level of detail, making the machine more accurate and user-friendly.



## Automatic repeat detection

With this feature the machine automatically detects the repeat size of the sleeve.

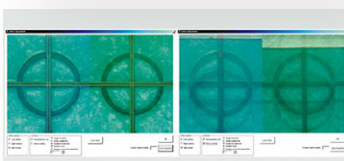

## Overlay System (patented)

Once the first plate is in the right position, the overlay module enables the operator to take snapshots of the mounting marks, which are then shown semi-transparently when mounting the other plates.

## Options Overview



### Automatic easyreg detection

Using our patented image recognition system, a visual mark on the edge of a sleeve such as the W&H Easyreg strip can be automatically 'set to zero' on the MOM, SAMM and FAMM mounting machines by simply pushing a button. The camera automatically homes in on the Easyreg mark and also automatically 'sets zero' in X and Y direction with 0.001mm (1µm) accuracy.

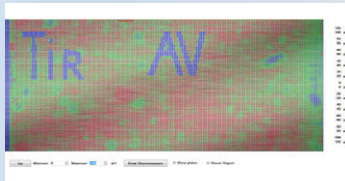

### TIR Sleeve Measurement

The TIR Measurement System analyses the quality of the printing sleeve or cylinder by measuring the "3D landscape" of the surface. By using the TIR system, press downtime due to out-of-spec and damaged sleeves is prevented. Better control over the printing process is gained, while the need to adjust the pressure of a sleeve during the set-up of the press is reduced.



### Tape holder on precision rail

A tape holder can optionally be added to MOM and SAMM machines on precision linear guides. The linear guides make sure the tape roll is completely parallel to the sleeve when applying tape and assist the operator to easily move the tape along the side of the sleeve.



### Cutting knife for plates and tape

A special cutting knife can be slid around the whole length of the machine and cut the tape seamlessly. It is made with a precise depth adjustment, therefore the sleeve is not damaged from cutting.



### Shaft coupling for cylinders

Shaft coupling for cylinders is driven by a harmonic drive. The shaft coupling is mounted on precision rails and can slide onto the cylinder shaft using a hand wheel that actuates the horizontal movement. The coupling is manually fastened by a locking mechanism that tightens a collar around the shaft, preventing any play. The shaft diameter should be the same for all cylinders.

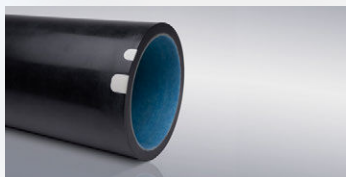

### Sleeve tracking system

Feature on the TIR. A database that tracks sleeves using the sleeve ID, which can be read using a barcode or RFID chip. The TIR sleeve measurement is then stored in this central database. Things such as run length, run times can also be added.



### Barcode scanner

A barcode scanner can be optionally added to the MOM, SAMM or FAMM for automatic loading of the jobs. The jobs are then usually made offline in prepress to optimize the machine Operation Equipment Effectiveness (OEE).



### Critical spare parts package

It is recommended to opt for a critical spare parts package, which is available for all equipment. AV Flexologic has spare parts warehouses in Western Europe: Alphen aan den Rijn, The Netherlands (HQ), North America: New Hudson, Michigan, USA and Eastern Europe: Cluj-Napoca, Romania.

# Flexo Wide-Web Product Summary

Specifications	MOM DD S	MOM DD+ PRO	SAMM 2.0	FAMM 3.0
Max Width (mm)	1300, 1700	1300, 1700, 2200	1300, 1700, 2200	1300, 1700, 2500
Max Width (inch)	52", 67"	52", 67", 87"	52", 67", 87"	52", 67", 87"
Max Repeat (mm/inch)	1350/ 53"	1350 / 53"	1350 / 53"	1350 / 53"

Features & Options	MOM DD S	MOM DD+ PRO	SAMM 2.0	FAMM 3.0
Automatic HD cameras	✓	✓	✓	✓
Customized Air mandrel	✓	✓	✓	✓
Motorized rotation of cylinder	✓	✓	✓	✓
Fixed distance from lens to plate	✓	✓	✓	✓
Vertical Movement of Cylinder	✓	✓	✓	✓
Mounting table	✓	✓	✓	✓
Laser pointers	✓	✓	✓	✓
Touchscreen	✓	✓	✓	✓
Camera encoders	✓	✓	✓	✓
Pressure roller	0	✓	✓	✓
Overlay system		✓	✓	✓
Digital Zoom capability		✓	✓	✓
Quality Report		✓	✓	✓
Digital Calibration System		✓	✓	✓
DOAL Lights		✓	✓	✓
Windows 10 mounting software		✓	✓	✓
Image Recognition Software		0	✓	✓
Quality check w/ image recognition		0	✓	✓
Motorized mounting table		0	✓	✓
Vacuum table			✓	✓
Robotic positioning			✓	✓
Automatic repeat detection			✓	✓
Automatic mandrel rotation			✓	✓
Robotic manipulator				✓
Conveyor belt for loading multiple plates				✓
Linear motors				✓
Second automatic pressure roller				✓
Barcode Scanner		0	0	0
Automatic Easyreg detection		0	0	0
Tape holder on precision rail	0	0	0	
Cutting knife for tape and plates	0	0	0	
TIR Sleeve measurement		0	0	
Sleeve Tracking System*		0	0	
Shaft Coupling for cylinders		0	0	
Automatic plate ID detection				0
Robotic tape application				0
Robotic sleeve loading/unloading				0
Robotic plate loading				0

✓ = Included 0 = Optional  
\*only in combination with TIR



## LIGHTWEIGHT TECHNOLOGY

Tech Sleeves® manufactures light weight composite sleeves and bridges for the global flexographic printing industry. By using the highest quality grade of materials, Tech Sleeves® is able to outperform any sleeve on the market in terms of durability, consistency and dimensional accuracy.

Tech Sleeves® and Tech Bridges® are qualified for high printing speeds of up to 800 m/min, or 2,624 ft/min and within the industry they are recognised as one of the lightest, stiffest and stable sleeve and bridges on the market with weight savings of up to 40%.



### LIGHTWEIGHT SLEEVES & BRIDGES

Advanced lightweight technology reduces the weight of the sleeve and minimises overall press bounce for outstanding printing results



### DURABLE INNER CORE

Our inner core featuring a combination of Dyneema and vinyl ester resin ensures the core of the sleeve withstands the the constant pressures of cylinder loading and unloading



### VINYL ESTER RESIN OUTER LAYER

The hardened UV cured outer layer (82 ShoreD) makes our sleeves the hardest and the stiffest in the flexo print market

## CONFIGURATIONS

FEATURE	ADVANTAGE	TECH LIGHT®	TECH PRO LIGHT®
Axial zero line	Helps in defining the zero position	●	●
Milled slot	A durable slot solution	●	O
Sealed edges	Ensures chemical and moisture protection providing dimensional stability	●	●
Rubber edges	Provides maximum durability		●
Metal Reinforced Slot	Great notch durability, bonded in the rubber for maximum durability, so not possible to come loose		●

“O”: Optional

### Sleeve Options

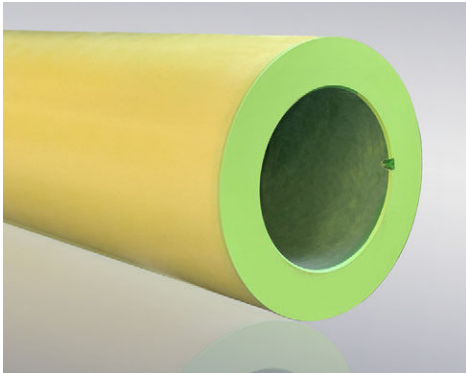

#### RUBBER SEALED EDGES WITH REINFORCED SLOT

Increases the lifetime of a sleeve by making the end of the sleeve resistant to impact. Prevents damages to the positioning pins in the press and mounting machines without weakening the registration slot.

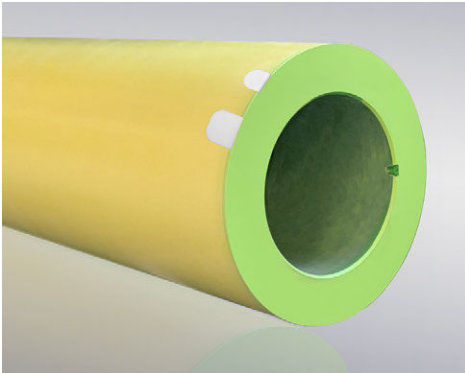

#### SMART SLEEVE (RFID CHIP & MAGNET)

RFID embedded sleeve which allows reading and writing for the purpose of identification. Works with the new and our existing systems. It improves the printing process and prevents mistakes from using the wrong sleeves in the press.

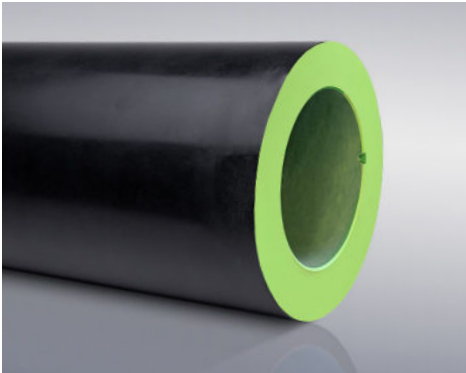

#### CONDUCTIVE SLEEVE

All the sleeves from Tech Sleeves can become conductive sleeves with the use of carbon. Conductive sleeves conduct electrostatic charges, which can occur in the printing area and go into the grounded printing press. Many companies choose this type of sleeves for printing.

## Tech Bridge®

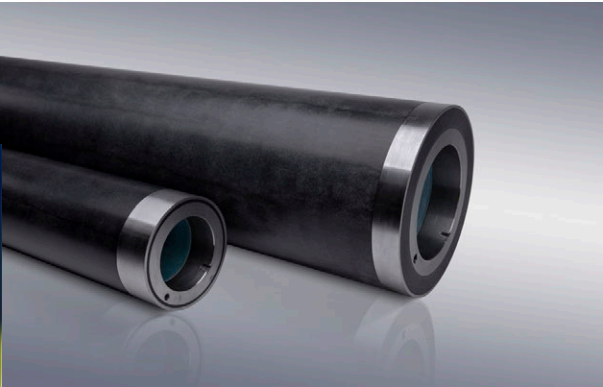

### Description

**Tech Bridge®** has an ultra high strength composite core complemented by a fiber-reinforced outer shell, which makes it suitable for high speed printing. It is available with a separate air connection or as air-through. Miller valves are standard for Separate Air Tech Bridges® that have a minimum wall thickness of more than 25mm. This high quality Hard Coated Bridge Sleeve is suitable for all plate sleeves.

The Tech Bridge comes standard with an outer metal ring protecting the edges of the bridge on both sides.

### Features & Options

- ✓ Sealed edges
- ✓ Full inner metal ring
- ✓ Outer metal ring incl. pin
- ✓ Miller valves
- ✓ Air Through or Separate Air
- ✓ Conductive by use of carbon



## Supporting Equipment

### Sleeve Storage System



### Description

This customized **Sleeve Storage** system allows easy access, storage and retrieval of sleeves. This is a customizable project based on your sleeves. The Sleeve Storage System can be extended by adding more racks in the future. The shelves are adjustable and the pins are made depending on your sleeve repeats.

### Advantages of the Sleeve Storage System

- ✓ Easy and fast retrieval of sleeves
- ✓ Prevents sleeve swelling due to the vertical storage
- ✓ Prevents sleeve damage thanks to the protective mat
- ✓ Saves time and effort
- ✓ Fully customized project



# Supporting Equipment

## TIR Measurement System



### Description

The **TIR** measurement system is the winner of the International print & innovation award 2015. It analyses the quality of the printing sleeve or cylinder by measuring the '3D landscape' of the surface. This information gives a thorough insight on the condition of the printing sleeve or the cylinder. With that, the TIR builds up a record of the exact condition of each printing sleeve or cylinder in stock. Subsequently the printing sleeves can be placed in the press with the right pre-settings.

The ability to check the exact condition of each sleeve is essential for high-speed production with minimum pressure settings on the press. Worn out or damaged sleeves are easily detected, which prevents bad quality sleeve related downtime in the printing presses. It also helps to create an inventory of sleeves that are fit for use.

### Advantages

Reduction in press downtime due to worn out printing sleeves which end up in the flexographic printing press

Quick and easy usage

Rigid steel construction

Prevent press downtime

Identify out-of-spec. sleeves

Allows better control over the printing process

Stores the measurement report

### Options

Tape holder for applying double-sided adhesive mounting tape

Cutting knife with an adjustable depth to prevent sleeve damage while cutting tape

Pressure roller for tape application

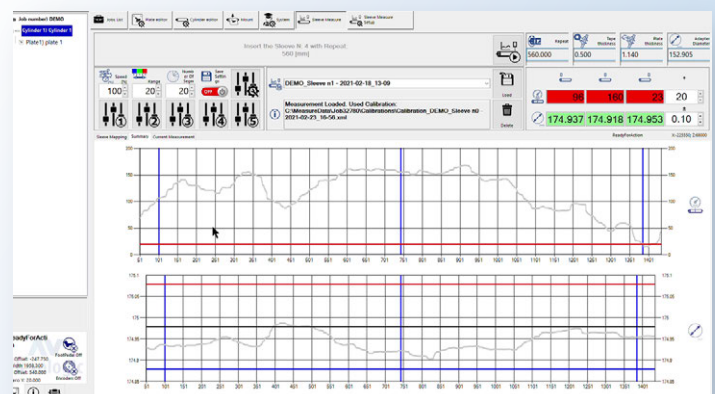
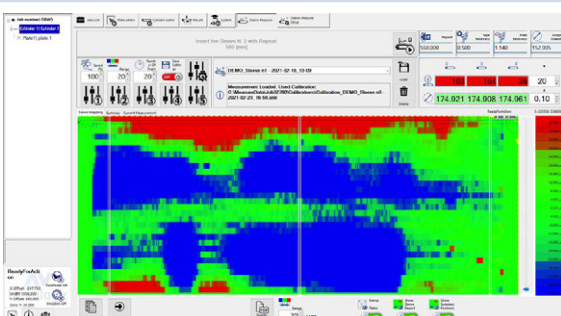

## Demounter



### Description

The **Demounter** is a machine designed to prevent damaging the printing plates. The Demounter efficiently removes the flexographic printing plates and mounting tape from sleeves, without any damage. A motor driven silicon roller generates friction to pull the printing plates and mounting tape off the printing sleeve or cylinder. The roller divides equal force along the entire width of the printing plate, as opposed to the edges, which protects the printing plates from any damage.

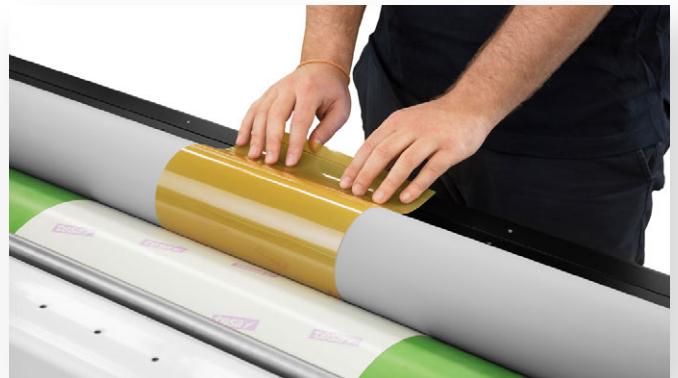

### Advantages

Reduces costs due to damaged printing plates allowing a quick return on investment

Saves time in prepress department

Easy to use and minimal force required

Rigid steel construction

Plug-and-play



### Options

Pneumatic cones for applying tape

Cutting knife

## Tape Applicator/Demounter



### Description

The **TAD** (Tape Applicator/Demounter) offers safe, fast and consistent tape application, while it can also be used as a Demounter to safely demount flexo plates and tape from sleeves, without damaging them.

### Features

Light and sturdy tape roller

Cutting knife with an adjustable depth to prevent sleeve damage while cutting tape

Motorized rubber roller, which distributes the force equally over the entire width of the sleeve

Teflon knife for detaching the plate from the sleeve easily and without damaging the plate

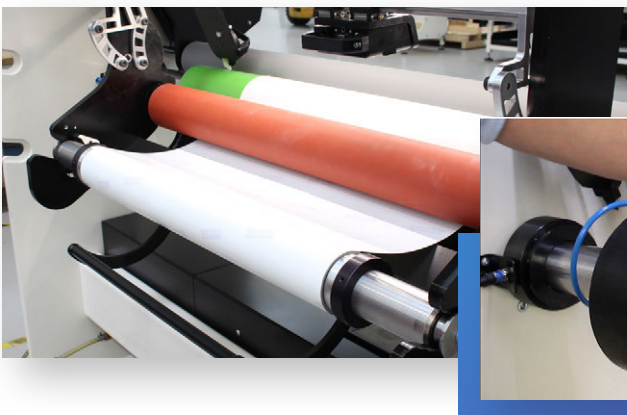
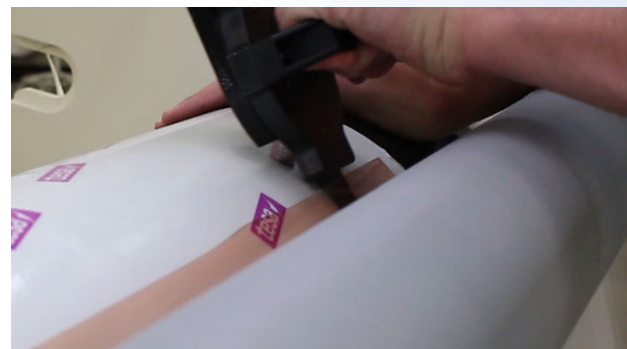

### Advantages

Perfectly aligned tape without air bubbles

Minimal tape waste

Easy to use and minimal force required

Rigid steel construction

Prevents plate and sleeve damage



## Global Support Network

24/7 assistance ☎ +31 (0) 172 503 621



Do you need urgent support? Call us at any time!

Our team is consisted of 24 exprienced engineers who can help you with any problem you might face. We provide support in: English, German, Spanish, French, Italian, Dutch, Romanian, Arabic and Thai.

## AV Flexologic Care

We are happy to introduce the new AV Flexologic Care Packages that provides you support even after the warranty expires.

### Package 1

- 24/7 Support
- Remote Support
- 1 Visit per year
- Software updates
- 15% Discount on spare parts
- Warranty extension on parts & labour\*

### Package 2

- 24/7 Support
- Remote Support
- 1 Visit per year
- Software updates
- 15% Discount on spare parts
- Warranty extension on parts & labour\*

### Package 3

- 24/7 Support
- Remote Support
- 1 Visit per year
- Software updates
- 15% Discount on spare parts
- Warranty extension on parts & labour\*

Request your own AVF Care package at [av@flexologic.nl](mailto:av@flexologic.nl) or call us at +31 (0) 172 503 621

## You can contact us easily in many ways:



Call us at **+31 (0) 172 503 621** or **+1-800-467-1746** for USA



We create an account for you at our Support Portal in Freshdesk. You can always raise a ticket when you log into your account.



Send an email to **support@flexologic.nl**

By sending your email, a ticket is automatically created in our system and we will support you in a short time



Visit our website at **www.flexologic.nl/support** and fill in the contact form.

By sending the form, a ticket is automatically created in our system and we will support you in a short time

## What happens next?

Once we receive your ticket or email, we will support you in the following ways:



**Ticket received!**  
Our service team will contact you soon



A.



**Remote support via telephone**

No Solution?

B.



**Remote assistance via TeamViewer**



C.



**We will send an engineer to repair your machine**



**Do you want to easily find information about your machine?**

Our support portal is designed to provide you instant help. By logging in to Freshdesk, you will be able to find information about your machine and answers to frequently asked questions

For additional information about Support & Service, visit our website: [www.flexologic.nl/support](http://www.flexologic.nl/support)

# COMPLETE FLEXO SOLUTIONS FOR EVERY FLEXOGRAPHIC PRINTER

[www.flexologic.com](http://www.flexologic.com)

[sales@flexologic.nl](mailto:sales@flexologic.nl)

H. Kamerlingh Onnesweg 2,  
2408 AW Alphen aan den Rijn,  
Netherlands

+31(0) 172 434 221

