

ROTARY JOINTS SERIES DS

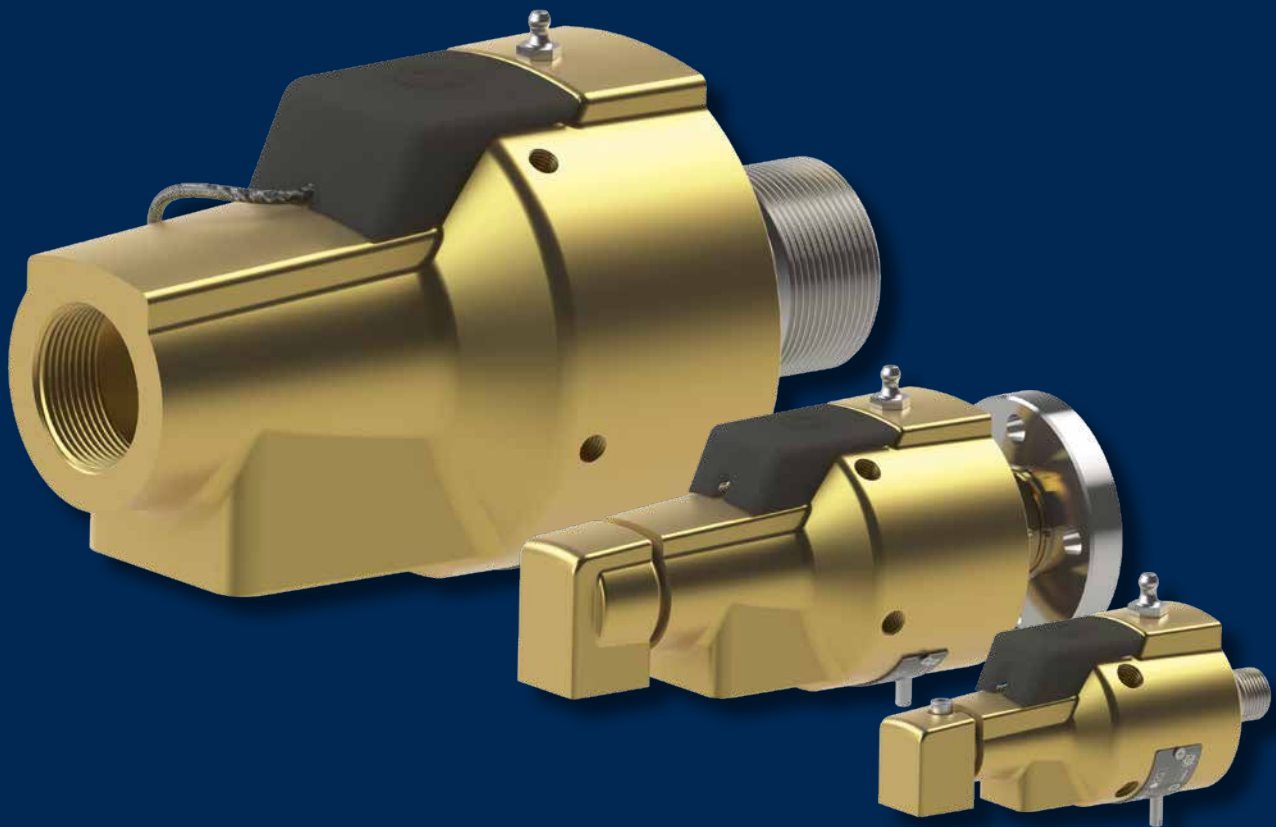

SENSOR READY SUPERIOR PERFORMANCE SMART CUSTOMISING

Rotary joints of the DS series are suitable for high speeds with low frictional torque, especially suitable for non-driven rolls. They are available from size DN 10 (3/8") to 80 (3 1/2") as mono- and duo-flow versions and are designed for the passage of water, heat transfer oil, air and technical gases.

Optionally, a monitoring sensor system for seal wear and other process values can be integrated. The recipe for success of the maierGROUP's rotary joints: intensive development, combined with tests in the laboratory and in practice - for high performance of machines and plants in different industries.

MODULAR DESIGN

- + 1:1 interchangeability
- + Simplified stock-keeping
- + Fast availability

INTERNAL PIPE SUPPORT

- + High flexibility
- + Wear-optimised (B2) principle
- + Smooth running even at high speeds (B2)

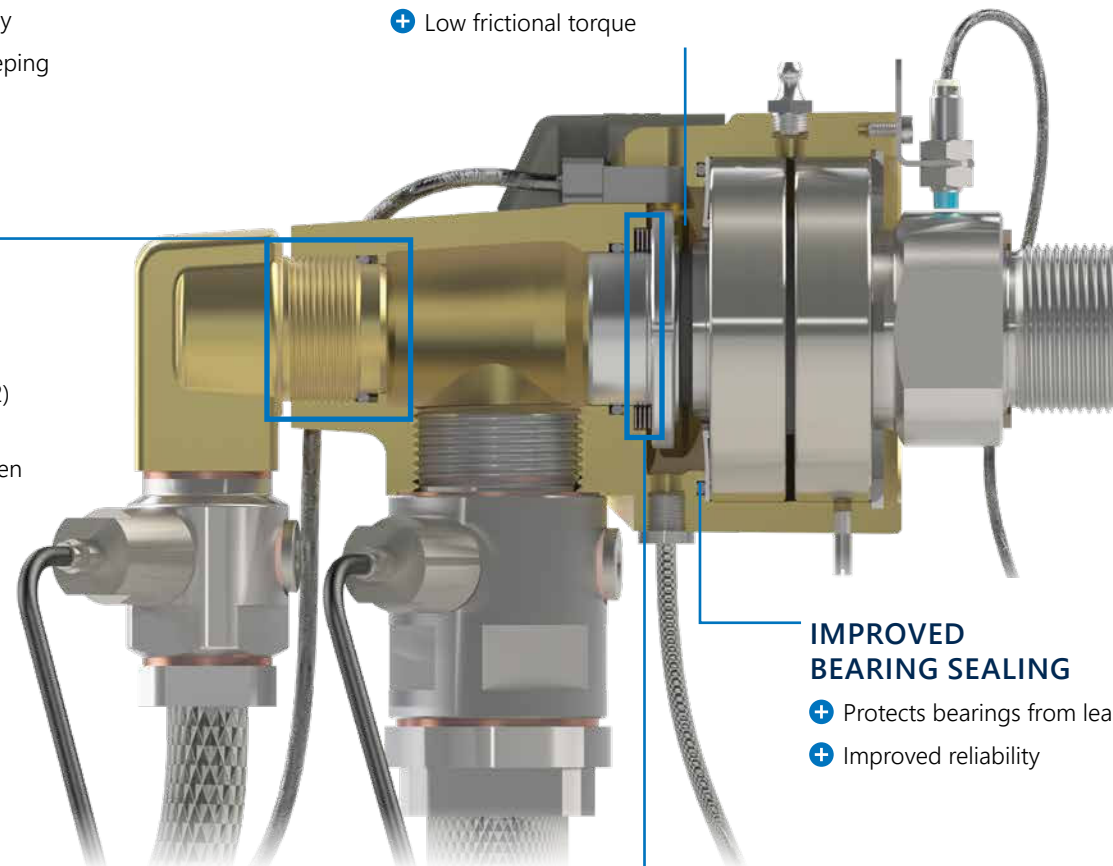

HIGH-END MECHANICAL SEAL

- + Highest reliability
- + Longest service life
- + Low frictional torque

IMPROVED BEARING SEALING

- + Protects bearings from leakage
- + Improved reliability

INTELLIGENT SENSORS (retrofitable)

- + Condition monitoring
- + Safety monitoring
- + Process monitoring

COMPRESSION SPRING OUTSIDE OF THE MEDIA FLOW

- + Higher flow rate
- + Better flow characteristics
- + Minimum pressure drop

Learn more about the series DS.



DESIGN CHARACTERISTICS

- Self-supporting design
- Two ball bearings, lubricated for life up to 80°C
- Primary seal: mechanical seal (axial)
- Secondary seal: O-rings
- Bearing protection seal: lip seal and O-ring
- Modular design

HOT WATER

COOLING WATER

HEAT TRANSFER OIL

AIR / TECHNICAL GASES

MAXIMUM APPLICATION DATA

The possible application data result from the selected sealing combination. The combination of maximum values should be avoided. Deviating media and application data on request.

No.	Sealing combination		Medium	Temperature	Pressure
1	Stainless steel	Synthetic carbon	Water	-10 ... + 80°C	10 bar
3	Superhard	High-performance carbon	Water, Heat transfer oil	-10 ... +140°C 0 ... +160°C	10 bar
4	Superhard	Superhard	Polluted water	-10 ... +140°C	10 bar
5	Superhard	Synthetic carbon	Air, Water-glycol mixture	-10 ... +120°C	10 bar

MAXIMUM FLOW RATE in relation to the nominal size DN

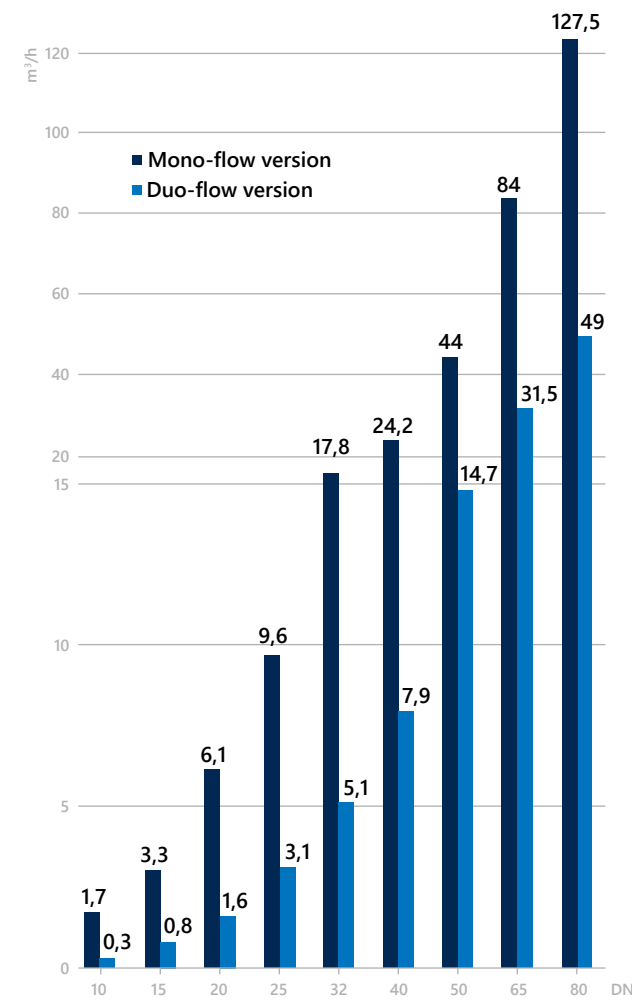

At maximum flow rate, the pressure loss is approx. 1 bar.

MAXIMUM SPEED

In relation of sealing combination to nominal size

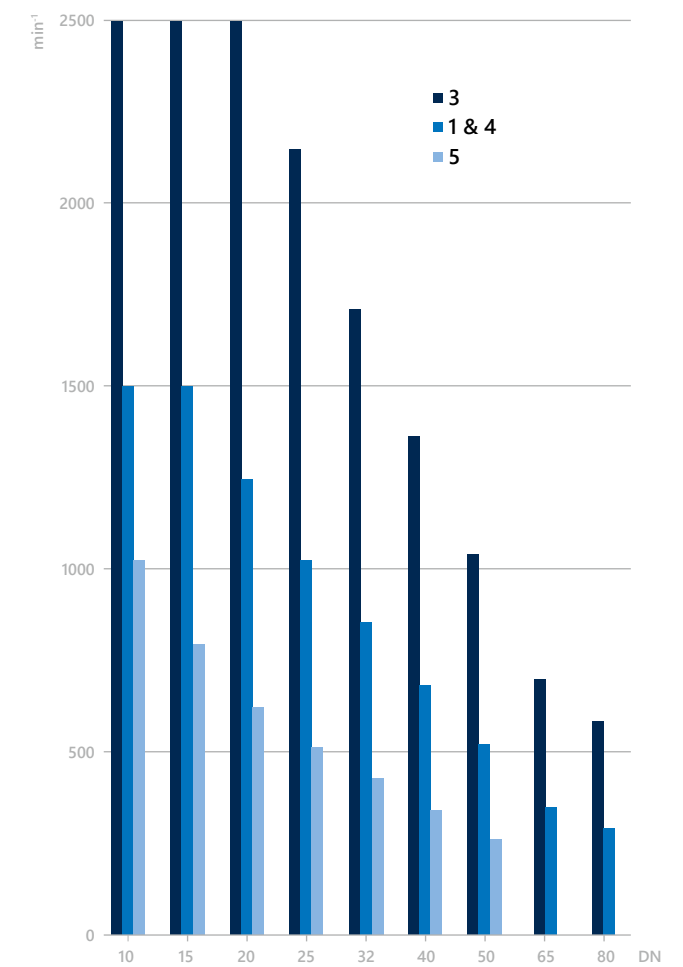

Sealing combinations 4 and 5 available for nominal sizes 10 to 50.

MODULAR IN EVERY RESPECT

The rotary joints of the DS series are characterised by their modular design. The **ordering designation** is used to determine the type, nominal size, connection-, and seal specifications.

SERIES

- DS** Rotary joint
- DSI** Rotary joint with integrated wear sensor - Sense W (further sensors on request)

NOMINAL SIZE DN IN MM
10, 15, 20, 25, 32, 40, 50, 65, 75, 80

DS I R2 40 R 5 1 5 -X1297

VARIANT INDEX FOR SPECIAL DESIGN

- X_** Generated by our **maierCONFIGURATOR** according to the modular system
- S_** Special design that goes beyond the modular system, is assigned by the factory

DESIGN

Mono-flow version

- 1** No inner pipe

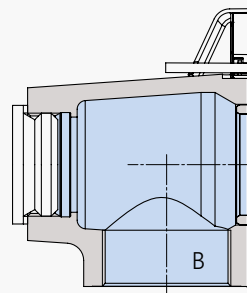

Duo-flow version

- 2** For fixed inner pipe (screwed in)

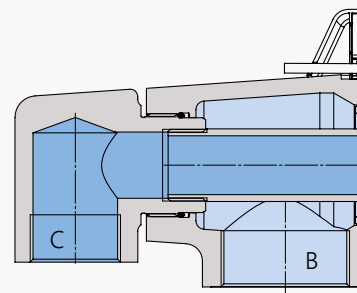

Housing connection B radial - Housing connection C radial

Housing connection B radial - Housing connection C axial

- R2** for rotating inner pipe, borne in elbow-, or slide bushing

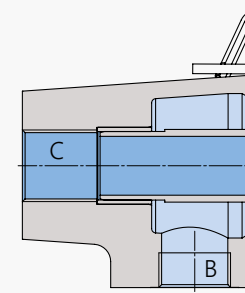
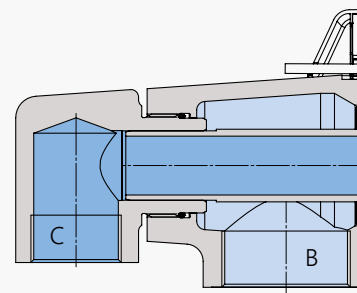

- O2** Fixed inner pipe floating, secured with screw

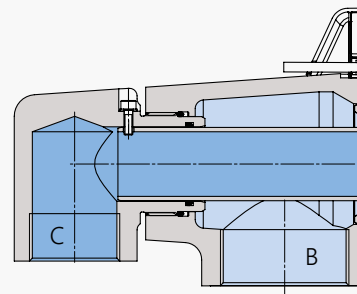

- B2** for rotating inner pipe, statically supported in the rotor

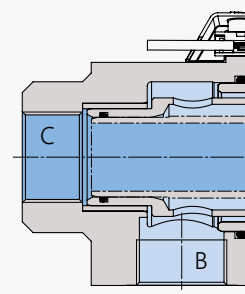

HOUSING CONNECTIONS

- 1** G thread (B radial, C radial)
- 2** NPT thread (B radial, C radial)
- 6** NPT thread on B, NPSC thread on C (B radial, C radial)

- 3** G-thread (B radial, C axial)
- 4** NPT thread (B radial, C axial)
- 5** Flange connections
- 9** Special version

SEALING COMBINATION OF MECHANICAL SEAL SET

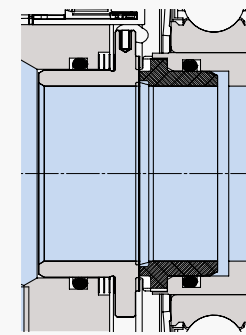

No.	mechanical Seal	counter face
1	Stainless steel for water up to +80°C	Synthetic carbon
3	Superhard for water up to +140°C for heat transfer oil up to +160°C	High performance carbon
4	Superhard for contaminated water up to +140°C	Superhard
5	Superhard for air up to +120°C for water-glycol mix up to +120°C	Synthetic charbon

ROTOR DESIGN

- R** Right-hand thread
- L** Left-hand thread
- F** Fixed flange
- K** K-flange (loose flange)

ROTOR CONNECTION- AND SEAL

- 1** Copper sealing ring, G-thread
- 2** 60° centring and sealing cone, G-thread
- 3** BSPT thread
- 4** NPT thread
- 0** Fixed flange with O-ring or flat packing
- 0** K flange (loose flange) with flat packing

Sealing via thread

Dimensions



SENSOR READY maierCONNECT

- SAFETY
- ENERGY EFFICIENCY
- FORWARD-LOOKING
- MAINTENANCE
- PROCESS OPTIMISATION

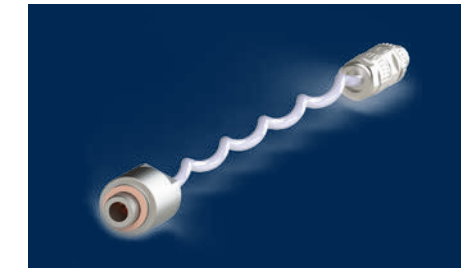

SENSE P/T
PRESSURE-TEMPERATURE-sensor
20 bar and up to 250°C

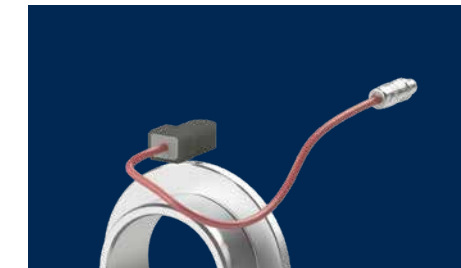

SENSE W
WEAR-sensor for
seal monitoring

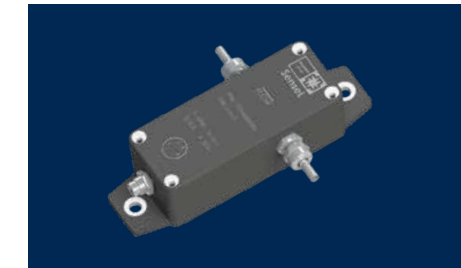

SENSE L
LEAKAGE-sensor for water
and oil



SENSE S
SPEED-sensor for simple
speed monitoring



LINK C
The efficient way to send
rotary joint data to the PLC
or the cloud via IO-Link.



The intelligent monitoring sensors can record all relevant rotary joint data. The "Link C" processing module converts the data into IO-Link.

The data obtained can be forwarded to your machine control or the cloud with the aid of evaluation electronics.



SUSTAINABLE SERVICE

With original spare parts from the **maierGROUP**, we guarantee the best quality, a long service life and high system availability. For the DS series, you can obtain complete repair kits that enable the simple replacement of wearing parts. Alternatively, we offer professional repair by **maierGROUP** specialists at the factory or at your site.

SENSE S

Speed monitoring

Simple monitoring, especially of non-driven rollers for "smooth" running.

SENSE W

Wear monitoring

Continuous monitoring of the mechanical seal can prevent **unplanned machine downtime** and detect unusual conditions.

STANDARD REPAIR KIT

This repair kit contains all components that are subject to mechanical wear (mechanical seal, roller bearing, slide bushing), or which have to be replaced due to ageing (elastomers). Additionally included are the fastening parts, such as screws and retaining rings which always have to be replaced during the repair. For the DSI version, the repair kit also contains spare parts for the wear sensor.

SMALL REPAIR KIT (DN65 TO DN80)

For nominal sizes 65 to 80, the main housing can be separated from the bearing housing for easy repair. For this reason - in addition to the comprehensive repair kit - a small repair kit is also available, which only contains parts of the mechanical seal. Depending on the maintenance interval, a choice can be made between minor and major maintenance.

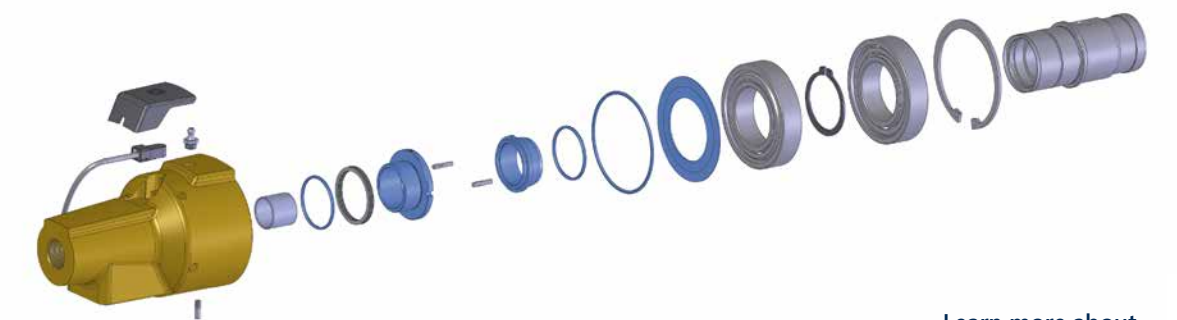

Learn more about our service.



SENSE L

Leakage monitoring

Unpredictable media leaks, especially environmentally hazardous media, are detected by the leakage sensor and thereby kept to a minimum.

SENSE P/T

Pressure and temperature monitoring

Monitoring important process parameters helps both the quality of the end product and the rotary joint by detecting and avoiding situations such as dry running.



Learn more about sensor technology.



SMART CUSTOMISATION maierCONFIGURATOR

With the **maierCONFIGURATOR** developed by **maierGROUP**, you can quickly and conveniently select the most suitable rotary joint for you. With the help of your operating parameters, the **maierCONFIGURATOR** will dimension the ideal rotating union. In addition, different connections, materials and installation positions can be selected. You will receive your configuration result conveniently by e-mail in the form of a drawing, a 3D model in STEP format and a commercial offer.



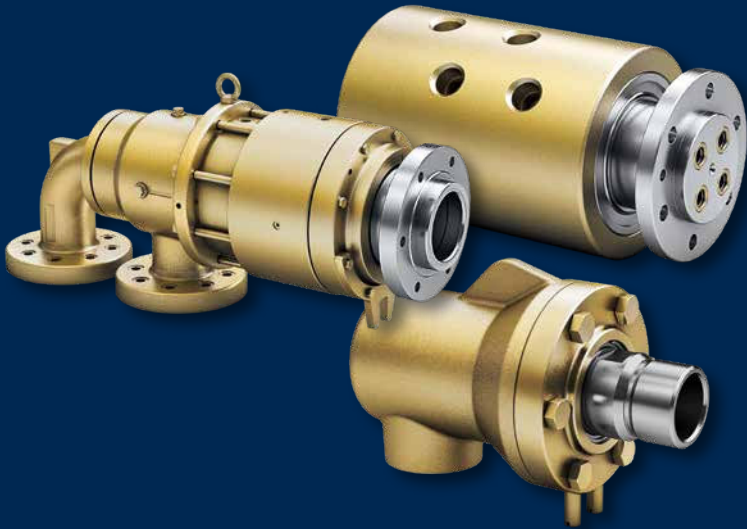

Rotary joints of the
maierGROUP –
a union for life

Christian Maier GmbH & Co. KG

Würzburger Straße 67–69
89520 Heidenheim
Germany

+49 7321 317-0
vkd@maier-heidenheim.de
maier-heidenheim.com

Maier Rotary Joints (Kunshan) Co. Ltd.

No. 329 Jujin Road, Zhang Pu Township
215321 Kunshan, Jiang Su Province
China

+86 512 368 53 832
sales@maierchina.com
maier-heidenheim.com/zh-hans/

Maier Rotary Joints Singapore Pte Ltd

4 Battery Road # 25-01
Bank of China Building
Singapore 049908

+65 6525 5198
jimmy.lim@maier-heidenheim.de
maier-heidenheim.com

Maier Italia S.r.l.

Via E. Toti 3
21040 Gerenzano (VA)
Italy

+39 0296 24 82 88
info@maier-italia.com
maier-italia.com

Maier America LLC

6669 Peachtree Ind. Blvd. Suite L/M
Norcross, GA 30092
USA

+1 770 409 0022
info@maieramerica.com
maieramerica.com