









CM5

The CM5 is a high voltage generator which incorporates all functions and features of previous version and more. A new patented feature "Advanced Current Control" is optionally available. Adjustable Output voltages of 0-30 or 0-60kV either positive or negative are capable of generating strong static charges, even at high velocities.

Standard functionality:

CM5 high voltage generators are equipped with the following standard functionality:

- +  Voltage Control and Current Control
- +  Password protected menu, lockable keyboard
- +  4 line LCD display with dual instructions (text + symbols)
- +  Analogue remote control functions and signals
- +  Quick set-up
- +  Advanced Current Control (patent pending)
- +  Advanced Output Control

Optional functionality:

- +  Serial bus interface (Profibus or CANopen)

Optional protocols can be installed at the time of order or can be retrofitted.

CM5 is fully backwards compatible with ECM30/60 and ECM DI30/60. The unit is fully electronically controlled via a menu. The menu language is selectable to English, German, French and Italian. For basic users a quick set-up menu is provided to set-up the generator to function as an ECM30/60. The new standard function Current Control will enable you to set a constant current vs a constant voltage. This will provide a much more stable charging and will compensate contamination and emitter pin wear automatically. Advanced Current Control is a revolutionary new feature. The generator keeps track of the supplied current to the electrode. It senses when there is no material to be charged and switches the current to a safe low level. This prevents spark-over and emitter pin wear. When material is reinserted the current will switch back to the high level current.



A serial bus interface can be fitted additionally to enable the generator to communicate through serial bus interfaces s.a. Profibus or CANopen (Other serial protocol available on request).

Advanced Output Control is optionally available for specific applications. This function provides output control that is proportional to an input signal. F.e. the level of charging can be proportional to the speed of the machine.

Menu

Various generator settings can be changed via the menu. This is done by using various key combinations or by configuring the various parameters. This advanced menu consists of main menus and submenus. Access to this menu can be protected with a user password.

Locked mode

If operating in local mode it is possible to lock the operation (temporarily). This is called 'locked' mode. In this mode it is no longer possible to change the output voltage or output current using the keyboard.

Serial bus interface module (optional)

A serial bus interface can be fitted additionally to enable the generator to communicate through serial bus interfaces s.a. Profibus or CANopen (Other serial protocols available on request). The generator is able to switch the high voltage on and off using an external switch signal. This is the Remote On/Off control. The CM5 high voltage generator has a communication bus stand-by function.

This function allows the generator to issue a "sleep mode" message via the bus communication system when the generator supply voltage is switched off.

An external supply voltage can be connected to the CM5, which allows the bus communication to be kept active when the generator is switched off.

Operating modes

The generator has a number of different operating modes:

- ⊕ Local mode: The high voltage or output current of the generator is set using the keyboard.
- ⊕ Remote mode: The high voltage or output current of the generator is set and read via external analogue control signals.
- ⊕ Fieldbus mode (Optional): The high voltage or output current of the generator is set and read via a serial communication interface.
- ⊕ AdvOutC mode: (Optional) Advanced Output Control mode. In this mode the high voltage that is set depends on an analogue control signal, e.g. speed control of the machine.

By using the generator's integrated menu structure, it is possible to switch between the various operational modes.

The generator has different ways of controlling the output voltage and current. The generator can be switched to VC/CV mode or CC mode.

- ⊕ VC / CV mode: Voltage Control or Constant Voltage. The generator will maintain the set voltage value and the current to be supplied by the generator will be adjusted to this.
- ⊕ CC mode: Current Control or Constant Current. The generator will maintain the set current value and the output voltage to be supplied by the generator will be adjusted to this.
- ⊕ AdvCC mode: (Optional) Advanced Current Control mode. The generator operates in an intelligent CC mode, with the ability to switch back to the stand-by state when no object is present below the connected electrodes.

Operation in Voltage Control mode

When the generator is operating in the VC mode, the desired output voltage is set on the generator. The generator now maintains the set output voltage and, depending on the load, adjusts this with a larger or smaller current. The charging current decreases, however, if the electrodes become dirty.

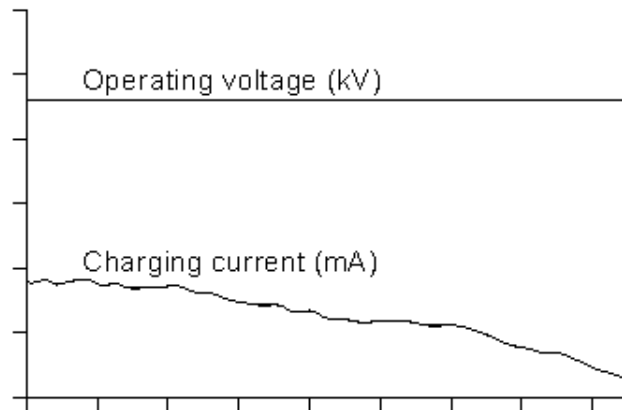

Operation in Current Control mode

When the generator is operating in the CC mode, the desired current is set on the generator. The generator now maintains the set current and adjusts this with a higher or lower output voltage. This method of control results in a constant ion current, or constant charging.

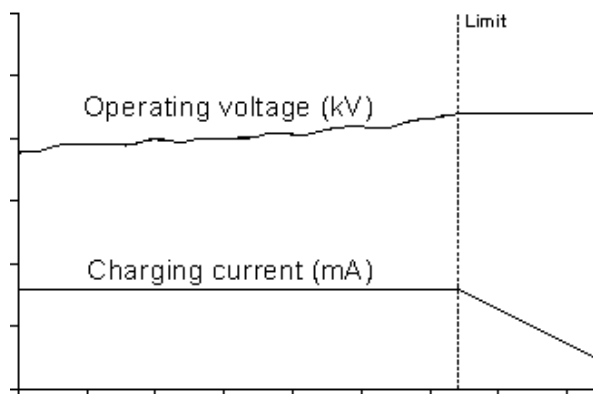

Operation in Advanced Current Control (AdvCC) mode

In the Advanced CC mode the generator will again operate in CC (Constant Current) mode. However, the generator, due to variations in the output voltage, will be able to detect whether an object has left the electrodes and whether it can switch back to a lower current control value. In this stand-by

mode a new object will be able to be detected and the generator will be able to again switch back to the preset current value in order to allow proper charging of the object.

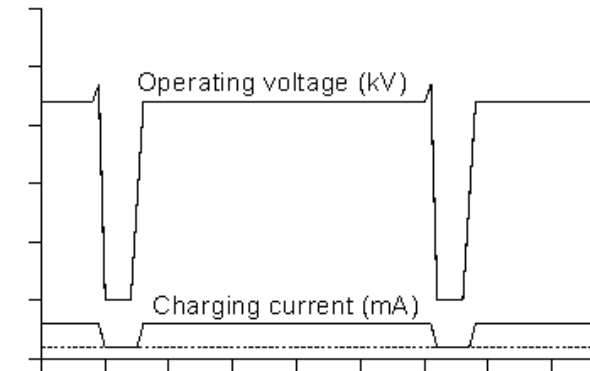





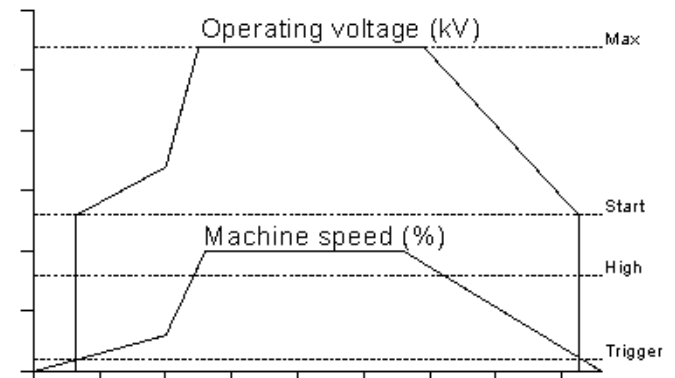







Operation in Advanced Output Control (AdvOutC) mode

In the Advanced Output Control mode the generator is engaged in voltage controlled charging (see VC mode). However, in this control mode the emitted high voltage depends on a control voltage. This will usually be related to the speed of a machine. In this mode a minimum and maximum voltage are specified in combination with a threshold and a maximum for the control voltage. As soon as the analogue control voltage is higher than the threshold voltage, the minimum set high voltage is supplied to the output of the generator. This will be increased linearly until the maximum set output voltage, as the control voltage, reaches the maximum level.



CM5 display



-  Generator is operating in Voltage Control (VC) mode.
-  Generator is operating in Current Control (CC) mode.
-  Generator is operating in Advanced CC (AdvCC) mode.
-  Generator is operating in Advanced Output Control (AdvOutC) mode.
-  High voltage is switched on.
-  Keyboard is locked.
-  External on/off mode is enabled.
-  RunButton mode is enabled.
-  Rotating dash, serial communication is operational.
-  Flashing E, communication problems.
-  Parameter cannot be changed.
-  Hi-Current (Nominal) mode during AdvCC mode.
-  Lo-Current (Standby) mode during AdvCC mode.

The main screen of the generator shows the currently measured voltage and current and also the operational mode. Texts are shown on the left-hand side of the display and symbols on the right-hand side. The symbols that refer to an operational mode appear on the same line as the text.

When the generator is operated via the keyboard, this is called the 'local' mode. When the generator is operated via the external analogue control inputs, this is called the 'remote' mode. When the generator is operated via the serial communication, this is called the 'fieldbus' mode.

Technical specifications

	CM5-30	CM5-60
Housing material	steel, powdercoating	steel, powdercoating
Weight	8,2 kg	8,2 kg
Connections	4	4
I/O	Sub-D 25 p	Sub-D 25 p
High voltage reading	LCD display	LCD display
Cable	2,5 m with plug and Euro Connector IEC- 320	2,5 m with plug and Euro Connector IEC-320
Ambient temperature	0- 55 °C	0- 55 °C
Use circumstances	industrial	industrial
U primary	100- 240 V AC	100- 240 V AC
Frequency	50 - 60 Hz	50- 60 Hz
Power consumption	240 Watt max.	240 Watt max.
U secondary	0- 30 kV DC	0-60 kV DC
I secondary	0- 5 mA	0 - 2,5 mA
Polarity	pos. or neg	pos. or neg.
Limit indication	yes	yes
Standard	Voltage and Current Control Analogue remote control functions Lockable keyboard Advanced Current Control Advanced Output Control	Voltage and Current Control Analogue remote control functions Lockable keyboard Advanced Current Control Advanced Output Control
Options	Serial bus interface	Serial bus interface



CM5 180°

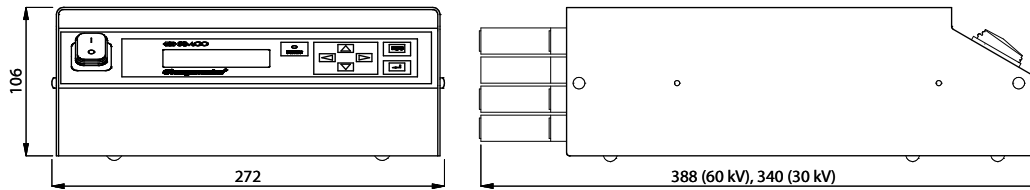
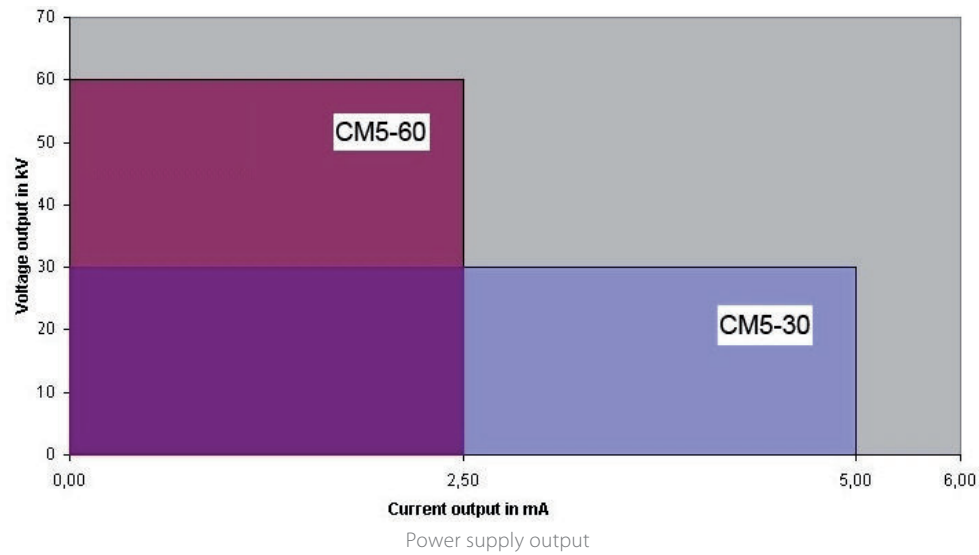

Technical drawing CM5

Simco-Ion Netherlands

Postbus 71
 Lochem, The Netherlands NL-7240 AB
 Tel: +31 (0)573 288333
 Fax: +31 (0)573 257319
 general@simco-ion.nl
 www.simco-ion.nl